

SPM33 Multifunction Power Meter

Installation & Operation Manual

V2.0

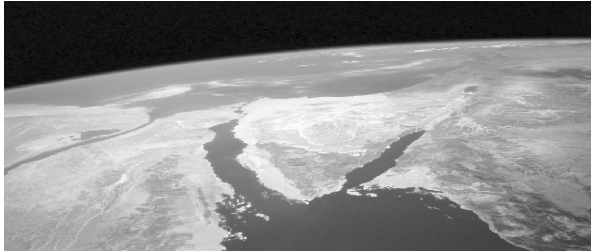



Danger and warning!

This device can be installed only by professionals.

The manufacturer shall not be held responsible for any accident caused by the failure to comply with the instructions in this manual.



Risks of electric shocks, burning, or explosion

- This device can be installed and maintained only by qualified people.
- Before operating the device, isolate the voltage input and power supply and short-circuit the secondary windings of all current transformers.
- Put all mechanical parts, doors, or covers in their original positions before energizing the device.
- Always supply the device with the correct working voltage during its operation.

Failure to take these preventive measures could cause damage to equipment or injuries to people

Contents

1. General Information	1
2. Order information	2
3. Dimension and Installation	3
3.1 Dimension	3
3.2 Installation	3
4. Operation	4
4.1 Real-time measurement data structure	4
4.2 The graphic display	5
4.3 Status Inquiry	6
4.4 Key Description	6
4.5 Parameter settings	7
5. Measuring Capability	13
5.1 Real-time basic electrical parameters	13
5.1.1 Voltage.....	14
5.1.2 Current.....	14
5.1.3 Frequency.....	15

5.2 Demand Parameters	15
5.3 Energy parameters.....	17
5.4 Harmonic parameters.....	17
5.5 Unbalance parameters	18
5.6 Alarm Setpoint.....	18
5.6.1 Alarm action condition.....	20
5.6.2 Alarm Output.....	21
6. Input/output Characteristics	21
6.1 Relay output.....	21
6.2 Status input	23
6.3 Dual Source kWh measurement	24
7. Technical Datasheet	25
8. Communication protocol	27
8.1. Introduction	27
8.2. Detailed Description of the SPM33 Modbus Protocol.....	28
8.2.1. SPM33 Modbus Protocol Rules.....	28
8.2.2. Modes of Transmission.....	29
8.2.3. Description of the Modbus Packet Structure.....	29

8.2.4. Abnormal Responses.....	31
8.2.5. Broadcast Packets.....	32
8.3. Packet Communication	33
8.3.1 Read the Relay Output Status (Function Code 01H)	33
8.3.2. Read Holding Registers (Function Code 03H).....	35
8.3.3 Relay Control (Function Code 05H).....	36
8.3.4. Preset Multiple Registers (Function code 10H).....	37
8.4. Calculating the CRC-16 Error Check Field.....	38
8.5. Description of SPM33 Registers.....	42
8.6 Description of Data Types	42
8.6.1 Real-time data register list.....	43
8.6.2 List of demand data registers.....	52
8.6.3 List of harmonic data registers.....	55
8.6.4 List of configuration registers.....	58
8.6.5 Register for command and clear energy.....	64
8.6.6 List of device information registers	65
9. Maintenance and Trouble Shooting	66
10. Appendix 1	69

1. General Information

SPM33 three phase multi-function power meters, mainly apply to Low Voltage Distribution System, which voltage below AC400V (L-N), it can through RS485/ Modbus communication to manage instrument of network, and achieve automatic control.

The main characteristics of SPM33 are as follows:

◆ Real-time parameter measurement

(Three-phase voltage, current, active power, reactive power, apparent power, power factor, frequency, active energy, reactive energy, and other combined electrical parameters measurement)

◆ Demand measurement

(Phase current demand, sub-phase active demand, total active demand, the maximum current demand, maximum total active demand, three phase reactive power, total reactive power, three phase apparent power, total apparent power demand, save their maximum value.)

◆ 2 active status inputs

◆ 2 relay outputs (optional)

◆ Alarm function

◆ Up to the 31st harmonic measurement, phase voltage and current harmonic content

(2 to 31),THD

◆ 1 RS485 communications, Modbus-RTU protocol

◆ Phase sequence adjustment

◆ Support Dual-source kWh measurement



2. Order information

SPM33 - <input type="checkbox"/> - <input type="checkbox"/> ① ②	
① : Feature selection	
R	Two relay alarm output
② : Rated identify measurement parameters	
V1	3×220/380V, 5A
V2	3×220/ 380V ,1A

Example: SPM33-R-V1: the low-voltage three-phase multifunction power meter, rated measuring 220/380V 5A, with standard 2 status inputs, optional 2 relay alarm output.

3. Dimension and Installation

3.1 Dimension

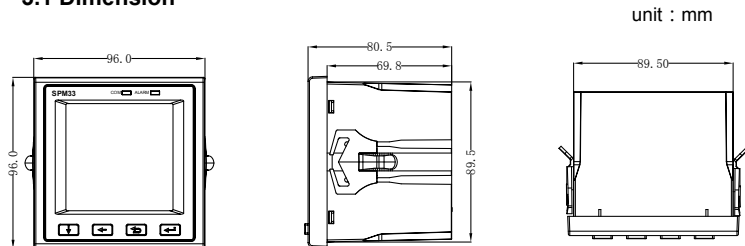

3.2 Installation

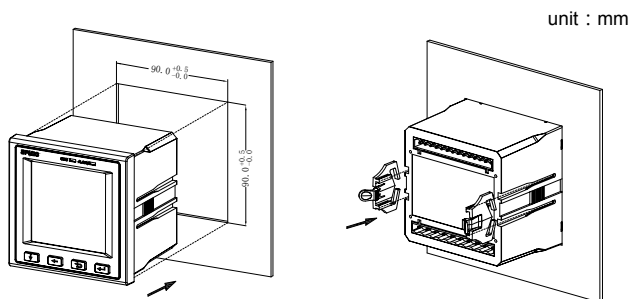



4. Operation

4.1 Real-time measurement data structure

(1) Real-time measurement data display by the form of main menu、submenu :

page button of main menu :  page button of submenu : 

(2) Menu tree diagram:

- ① Can flip the main menu by press .
- ② Can flip the submenu which under the main menu, by press .

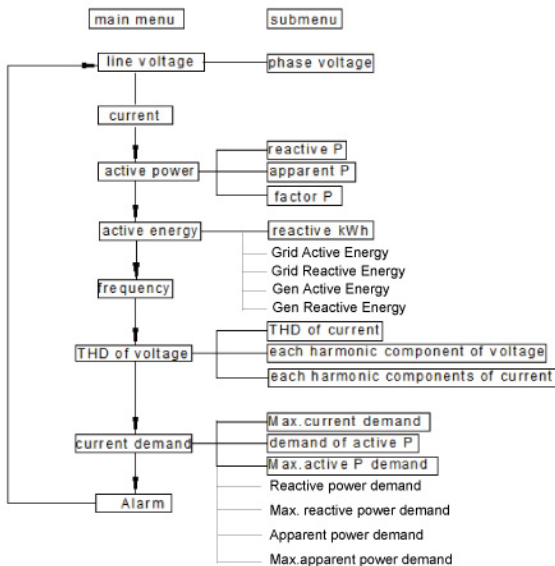

4.2 The graphic display

1 : Prompt of the currently displayed page ;

2 : Prompt display page number ;

3 : Status prompt of DI/DO ;

4 : Data display area ;

5 : Energy display area ;

6 : The secondary menu prompt ;

7 : Prompt under a main menu ;

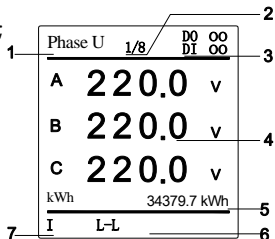

Description:

(1) If there is no key operation within 60s, the backlight automatically turns off, when the backlight is lit until the button operation again.

(2) Status prompt of DI/DO displays the current status of DI / DO ,each circle represents a DI or DO signal, when DI signal or relay is closed, the corresponding circle is solid; conversely, was hollow.



4.3 Status Inquiry

(1) COM lamp, always bright when power on, blinks when there is communication.

(2) ALARM lamp, flashes when there is an alarm, off when no alarm off.

4.4 Key Description

Note: In a different interface, the same keys have different functions.



Sibling menu switch / move the cursor to the right



Switching sibling menu to submenu / move the cursor to the left



Exit



Enter the menu / confirm

4.5 Parameter settings

■ Meter Programming

SPM33 can program the following

parameters :

Project programming	
CT values	Adjustment phase sequence
Communication	Language
Terminal Mode	Demo
Alarm	Password
Relay	Version
Clean	/

The projects of configuring different instrument is not completely consistent, not even, so the user should operate according to the specific circumstances of the instrument:

CT value : press key  to enter CT interface , the figure as below.

You can set ratio according to the site CT, CT setting range: 1 to 10000.

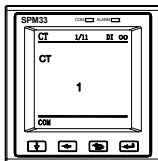

2. Communication: press key  to enter the communication interface, can set meter mailing address and baud rate, the figure as below. Mailing Address range: 1 to 247, the baud rate can be set: 4800, 9600, 19200



3. Connection mode: press key  to enter the interface, to set terminal mode according to the scene of the connection mode, figure as below. Terminal mode can be set: three-phase three-wire, three-phase four-wire;

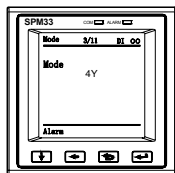

4. Alarm : Press key  to enter the voltage limit alarm interface, figure as below:

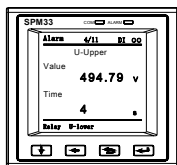

Press key , the user can view and set the other object of alarm:

Voltage limit, current limit, lower limit of current, frequency, frequency lower limit and upper limit, alarm of phase lack, the status 1 is broken.

- ① Action value of voltage upper limit :
unit is V , two decimal places.
Setting range: 110 ~ 500V.

Notice: action value of voltage upper limit must be greater than voltage lower limit.

Can be set to "0", "0" indicates that the alarm type is closed.

- ② Action value of voltage lower limit :

unit is V , two decimal places.

Setting range: 110 ~ 500V.

Notice: action value of voltage lower limit must be less than voltage upper limit. Can be set to "0", "0" indicates that the alarm type is closed.

- ③ Action value of current upper limit :

unit is A , one decimal places.

range : 1.0~60000.0A.

Notice: current is the value for the upper limit must be greater than current lower limit. Can be set to "0", "0" indicates that the alarm type is closed.

④ Action value of current lower limit :

unit is A , one decimal places.

range : 1.0~60000.0A.

Notice: current is the value for the primary side. Action value of current lower limit must be less than the current upper limit can be set to "0", "0" indicates that the alarm type is closed.

⑤ Action value of frequency upper limit :

Unit is Hz , two decimal places.

range : 45~65Hz.

Notice: action value of frequency upper limit must be greater than frequency lower limit. Can be set to "0", "0" indicates that the alarm type is closed.

⑥ Action value of frequency lower limit :

Unit is Hz , two decimal places.

range : 45~65Hz.

Notice: action value of frequency lower limit must be less than frequency upper limit. Can be set to "0", "0" indicates that the alarm closed.

⑦ Action value of power upper limit :

unit is kW , one decimal places.

range : 0.1~40000.0kW.

Notice: power is the value for the primary side. Can be set to "0", "0" indicates that the alarm

All of the above operation can set primary side. Action value of current type is closed.

the time of action , unit is s ,

range : 0~120s.

Notice: setting of voltage phase failure and status 1 off :

On---said opening the alarm type;

Off---said closing the alarm type.

5. Relay: press key  to enter the relay 1 interface, figure as below.

Mode: You can set the remote or alarm mode.

Reset time setting range: 0 ~ 120s.

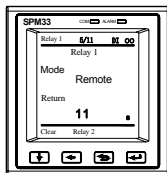

Press key , you can view the setting of relay 2 ,it can set as the relay 1.

6. Clear: press key  to enter the clear interface, figure as below. Can clear energy or demand.

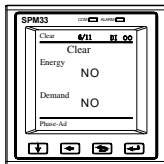

7.Phase sequence adjustment: press the keys  to enter the phase sequence

Adjust interface. figure as below , the user can adjust the current channel phase sequence and direction, which corresponding to voltage ,in accordance with the wiring on-site;

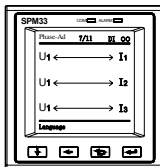

Voltage adjust current channel map, can be set to:

I1 : Channel voltage & I1 Channel current match,

-I1 : Channel voltage & I1 Channel current match, , I1 reversed polarity,

I2 : Channel voltage & I2 Channel current match, ,

-I2 : Channel voltage & I2 Channel current match,I2 reversed polarity,

I3 : Channel voltage & I3 Channel current match,

-I3 : Channel voltage & I3 Channel current match, , I3 reversed polarity,

8. Language: press key  to enter the language setting interface, figure as below, the user can choose Chinese and English languages.



9. Demo : press key  to enter Demo setting interface , figure as below.

OK : indicate open Demo mode

NO : indicate close Demo mode



10. Password: press key  to enter Password modification interface. figure as below



11. Version: press key  to enter the version display, figure as below, you can view the software and hardware versions of the instrument.

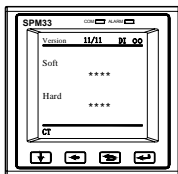



■ Precautions

1. when password authentication input password "33", the display the original password;

2. when instrument work under the three-phase three-wire mode , active power, reactive power and power factor are only the sum of the value, and there is no concept of a single-phase, single-phase value is 0;

3. For the instrument which do not support the relay output function, will not have the relevant settings menu;

4. When the data setting is invalid, the set is unsuccessful, restore the original parameters;

5. For other customization features, in this description does not describe!

5. Measuring Capability

5.1 Real-time basic electrical parameters

SPM33 provides voltage, current, power, and frequency etc. basic parameters.

Real-time reading	Measuring range
current	
Each phase	0 ~ 65 , 000A
Zero sequence	0 ~ 65 , 000A
Degree of unbalance (%)	0 ~ 100%
voltage	
Line-line	0 ~ 650V
Line-neutral line	0 ~ 400V
Degree of unbalance (%)	0 ~ 100%
Active power/Reactive power /Apparent power	
Single phase	0 ~ ± 26MW/var/VA
Total	0 ~ ± 78MW/var/VA
Power factor	
Single phase	-1.000 ~ +1.000
Total	-1.000 ~ +1.000
Frequency	
35 ~ 65Hz	35 ~ 65Hz



5.1.1 Voltage

SPM33 maximum measurement of phase voltage is 400V, three-phase three-wire line voltage can up to 500V. Users should be noted that during the design of this, to prevent internal measuring circuit saturation, resulting in inaccurate measurements. Wiring mode of voltage can be set by the panel or communication, support “Y” and triangle connection mode.

Recommendation: After changing the wiring mode, you'd best clear energy, re-accumulate energy.

5.1.2 Current

SPM33 must be conducted by CT to measure current. CT secondary rated output required to meet the input requirements of SPM33 rated current (5A or 1A). When using an external CT, wiring should prevent open, otherwise it will generate a higher voltage in the secondary role In the primary excitation effect, causing no casualties or damage to equipment.

SPM33 overload of current measurement channel is generally 1.2 times the rated current measurements. During the design of this users should be noted that, to prevent internal measuring circuit saturation, resulting in inaccurate measurements. SPM33 current measurement range: 0 ~ 65kA. Setting range of CT transformation ratio is: 1 ~ 10000A.

5.1.3 Frequency

SPM33 working on different measurement mode, the acquisition channel of the frequency measurement is not the same. In the triangle connection mode, SPM33 measures frequency default by AB line voltage channel ; under other modes, SPM33 measures the frequency by the A phase voltage channel. If phase A default phase, then take the C phase. If A, C-phase default phase, then take the B phase.

5.2 Demand Parameters

Demand refers to the value obtained in the following way: the accumulated electrical parameters within a period of time divided by the time length. To facilitate the operation of the user, SPM33 adopts the fixed-block calculation method in the fixed period of time, and the period of time is fixed, being 15 minutes.

SPM33 provides the following demand data and measuring ranges:

Demand reading	Measuring range
Demand current	
Current every phase	0 ~ 65 , 000A
Maximum peak	0 ~ 65 , 000A
Active power	
Every phase	0 ~ ± 26MW
Three-phase total	0 ~ ± 78MW
Maximum peak of every phase	0 ~ ± 26MW
Maximum peak of three-phase total	0 ~ ± 78MW
Reactive power	
Every phase	0 ~ ± 26MVAR
Three-phase total	0 ~ ± 78MVAR
Maximum peak of every phase	0 ~ ± 26MVAR
Maximum peak of three-phase total	0 ~ ± 78MVAR
Apparent Power	
Every phase	0 ~ ± 26MVA
Three-phase total	0 ~ ± 78MVA
Maximum peak of every phase	0 ~ ± 26MVA
Maximum peak of three-phase total	0 ~ ± 78MVA

The figure below describes demand calculation:

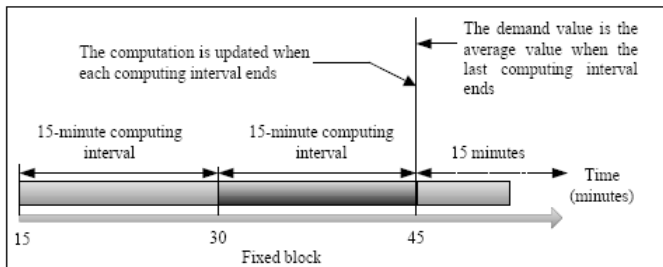

5.3 Energy parameters

SPM33 input and output of active and reactive energy, the maximum cumulative to 99,999,999.9, display one decimal place. When the accumulated value reaches to maximum, it will overturn automatically.

5.4 Harmonic parameters

SPM33 provides optional measurement of complete 31st harmonic for voltage and current as well as their total harmonic content (THD) .

The data of harmonics are given according to the percentage of fundamental harmonics and have one digit after the decimal point. That is to say, when the value of the fundamental harmonic is fixed at 1000, it is 100.0% of the effective value of the fundamental harmonic; others are by analogy.

THD refers to the total of higher harmonics except fundamental harmonics, and it is calculated according to the following formula:

$$THD = \sqrt{\sum_{i=2}^{i=n} X_i^2}$$

i : Harmonic order.

X_i : Percentage of the effective value of each harmonic to that of

the fundamental harmonic.

n : Highest harmonic order, which should be 31 here.

【Attention】 : Each harmonic and THD can be checked through display or communication.



5.5 Unbalance parameters

SPM33 can measure current unbalance, the unbalance is calculated:

$$X_{unbal} = (X_{max} - X_{min}) / X_{max} \times 100\%$$

X_{unbal} — The unbalance of the voltage or current

X_{max} — Maximum value of the three-phase voltage or current

X_{min} — Minimum value of the three-phase voltage or current

5.6 Alarm Setpoint

SPM33 with user definable valued system which can monitor the electrical parameters of the instrument and set the action. When an alarm event occurs, the instrument panel ALARM light will flash, meanwhile, the display can be switched to the alarm interface to see the type of alarm events, or read the type of alarm through communication, after the elimination of alarm events , ALARM light will destroy , warning interface will appear as "no."

The object of the alarm type as below:

Object	Alarm triggered	remark
The upper limit of voltage	maximum voltage value in three-phase voltage> the voltage setting upper limit (three-phase four-wire, voltage is phase voltage; three-phase three-wire, voltage is the line voltage)	the action value 0 indicates to close the alarm object
The lower limit of voltage	The minimum voltage value in three-phase voltages which is greater than 110V <the voltage setting lower limit (Three-phase four-wire, voltage is phase voltage; three-phase three-wire, voltage is the line voltage)	the action value 0 indicates to close the alarm object
the upper limit of current	The Max. primary current value in three-phase current > the upper limit of current setting value	the action value 0 indicates to close the alarm object
the lower limit of current	The Min. primary current value(nonzero) in three-phase current > the lower limit of current setting value	the action value 0 indicates to close the alarm object
The upper limit of frequency	Meter voltage frequency> the upper limit of frequency setting value	the action value 0 indicates to close the alarm object



The lower limit of frequency	Meter voltage frequency (nonzero)> the lower limit of frequency setting	the action value 0 indicates to close the alarm object
The upper limit of power	The total value of primary active power > the upper limit of power setting value	the action value 0 indicates to close the alarm object
Voltage open-phase	In three-phase four-wire, one phase or two-phase in three voltage <110V Three-phase three-wire ,one phase or two-phase in three line voltage<190V	The alarm can be set to turn on or off
Status 1 open	Status 1 from the closed to the open	The alarm can be set to turn on or off



5.6.1 Alarm action condition

SPM33 generated alarm condition: the setting object meet the action conditions, and need to meet the time requirements in order to be really activated.

Throughout the delay period, if the object is within the return limits, then the alarm setpoint is not activated. If the delay time is 0, it means that once the monitoring object is more limited, the alarm setpoint generated immediately.

There is a fixed value or more objects is active, the alarm is generated. After the alarm is generated, all the setting object if returned within the limit, the alarm will disappear.

5.6.2 Alarm Output

When the alarm occurs, the ALARM lights will flash, meanwhile, the LCD panel will pop up warning dialog box, then press key  to switch to the alarm interface to view the type of event alarms, press key  to return to the current interface. If don't press key within 5s, alarm box will disappear. Alarms type can also be read through communication, if the alarm associated relays, the relay generates action. Once the alarm disappears, the ALARM light will be off, the alarm interface will be displayed "no" at this time, if the alarm associated relays, the relay will be reset.

6. Input/output Characteristics

6.1 Relay output

SPM33 provides two relay optional modes, relay specification is 250Vac/5A, can be used with the instrument's alarm setpoint system, to monitor relative electrical parameters whether there is more limited, and thus output breaker reasonable action (details refer to the chapter of the alarm setpoint); Or can set the relay to remote mode, customers can according to their need to relay control; If you have special needs, please be specified when ordering.



SPM33 provides two relay operation modes. The action of relay is different in these two modes. The default control mode of this product is remote control. Users can modify to alarm control through panel relay setting or through communication.

- ◆ Remote control (external) - The relay is controlled by a PC or PLC by using commands through communication.
- ◆ Alarm Control (internal) - If there is an alarm generated, the relay on the action, you can refer to specific alarm setpoint alarm.
- ◆ When setting as Alarm mode, Alarm Subject including All, Voltage, Current, Frequency, Total active power, Voltage Phase lose, or DI 1 off, etc

Once the relay has been in the remote control mode, even if the alarms generated, it will not act, the relay mode must be set to alarm mode, then can operate the alarm action.

Reset (effective only under remote mode): When the relay acts, it can return to the state after N times (N is set reset time, can be set by the panel and communications, N = 0, the relay can't reset, that is, relay will not restore to original state).

Silencer: when elected relays, relay 1 in alarm mode, have a mute button function simulation, when an alarm occurs, the relay 1 will have action, under

the alarm menu interface if press the "mute" button, relay 1 will be reset. After the reset, if there is a new alarm generation, Relay 1 will re-action again.

Note: Relay 2 without this mute function.

6.2 Status input

SPM33 provides flexible 2-way nodes configurable input, applied to monitoring circuit breaker position signal, switch position signals and other status information.

SPM33 provides active status node, which need an external power source. The following 2-way status input as example to introduce this wiring mode.

◇ External active node wiring diagram is shown as below :

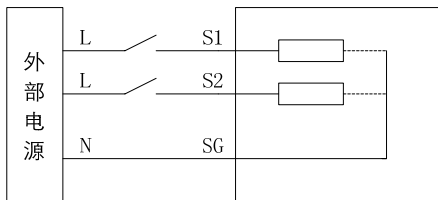

In general, the external node is closed, SPM33 LCD corresponding status input display is closed, while the internal state information is also set to 1; external node is disconnected, SPM33 LCD corresponding status input display is turned off, the internal state information is also set to 0.



6.3 Dual Source kWh measurement

DI 1 be defined as special function (register 40207), as dual source kWh measurement function

After start this function:

If DI 1 with status of ON, add energy value to Grid area (register 40052-40063), on the display will show Grid. And the value also will add to register 40026-40037.

If DI 1 with status of OFF, add total energy value to Generator area (register 40064-40075), on the display will show Gen. And the value also will add to register 40026-40037.

Customer can query total energy, Grid energy and Gen energy from the page of kWh (Active/ Reactive)

7. Technical Datasheet

Parameters		range	
Rated operating parameters	Rated Power Supply	AC 85~265V DC 100~300V	
	Rated input current	5A or 1A	
	Rated input voltage	3×220/380V 35Hz~65Hz	
	Status input Rated voltage	220V , 2 channel active status input, less than 60V is open, more than 140V is closed , Max. Input is 300V.	
	Relay output Rated contact capacity	AC 250V/5A or DC 30V/5A	
	parameter	range	Accuracy
Accuracy of electric parameters	voltage	10%~150%	0.5%
	current	1%~120%	0.5%
	Power factor	-1~1	1%
	Active energy	0~99999999.9	0.5%
	Reactive energy	0~99999999.9	2%
	Active power	Single phase : 0 ~ ± 26MW/var/VA Total : 0 ~ ± 78MW/var/VA	0.5%
	Reactive power		1.0%
	Three-phase current unbalance	0%~100%	1%
	Harmonic content	0%~100%	B 级
	parameters	Performance	
	Power Consumption	≤ 2W/5VA	
Cabinet temperature	Normal operating temperature	-10℃ ~ +55℃	
	Limit operating temperature	-25℃ ~ +55℃	
	Storage temperature	-40℃ ~ +70℃	
	Relative humidity	5% ~ 95% RH, non-condensing	
Insulation ability	Power frequency withstand voltage	2000VAC	
	Insulation resistance	≥ 100MΩ	
	Impulse voltage	6000V	
IP index	front panel	IP52	



	case	IP20	
	Project	standard	Test level
IEC	Electrostatic Discharge Immunity Test	GB/T17626.2-2006 (IEC61000-4-2:2001)	Class 4
	Radiated immunity test	GB/T17626.3-2006 (IEC61000-4-3:2002)	Class 4
	Electrical fast transient/burst immunity test	GB/T17626.4-2008 (IEC61000-4-4:2006)	Class 4
	Surge immunity test	GB/T17626.5-2008 (IEC61000-4-5:2005)	Class 4
	RF field immunity induced mass	GB/T17626.6-2008 (IEC61000-4-6:2006)	Class 3
	Radiated emissions limit	GB 9254-2008 (CISPR22 : 2006)	Accord
	Voltage dips, short interruptions immunity test	GB/T17626.11-2008 (IEC61000-4-11:2004)	Accord
	Power frequency withstand voltage	GB/T 17215.211-2006	Rated insulation voltage \leq 300V ,The test voltage 2000V. Rated insulation voltage \leq 60V , The test voltage 1000V. Leakage current \leq 10mA.

8. Communication protocol

8.1. Introduction

This document describes the input and output command, information and data of the SPM33 under MODBUS communication mode. So it is convenient for the 3rd part using and developing.

8.1.1 Purpose of the Communication Protocol

The purpose of the SPM33 MODBUS communications protocol is to allow setup information and measured data to be efficiently transferred between a MODBUS Master Station and SPM33. It includes:

- 1) Allowing setting and reading all SPM33 set-up parameters from a MODBUS Master Station.
- 2) Allowing reading all data measured by a SPM33 and SOE (Event log).

8.1.2 Version of Communication Protocol

This document is proper for all versions of SPM33 meters. It will be declared, if any change happens later.



8.2. Detailed Description of the SPM33 Modbus Protocol

8.2.1. SPM33 Modbus Protocol Rules

The following rules define the protocol rules for information transfer between a MODBUS Master device and the SPM33 in a RS-485 serial communications loop.

- 1) All communications on the RS-485 loop conforms to a MASTER/SLAVE scheme. In this scheme, information and data is transferred between a MODBUS MASTER device and up to 32 SLAVE monitoring devices.
- 2) The MASTER will initiate and control all information transfer on the RS-485 communications loop.
- 3) Under no circumstances will a SLAVE device initiate a communications sequence.
- 4) All communications activity on the RS-485 loop occurs in the form of "PACKETS", a packet being simply a serial string of 8-bit bytes. The maximum number of bytes contained within one packet is 255. The bytes that comprise a packet consist of standard asynchronous serial data, which are generated using equipment similar to that used for RS-232C.
- 5) The packages from MASTER are named request. The packages from SLAVE are named response.

6) Under any circumstance, Slave can just respond one request.

8.2.2. Modes of Transmission

MODBUS protocol supports ASCII and RTU modes of transmissions. The SPM33 supports only the RTU mode of transmission with 8 data bits, no parity, and one stop bit.

8.2.3. Description of the Modbus Packet Structure

Every MODBUS packet consists of four fields:

- 1) The Address Field
- 2) The Function Field
- 3) The Data Field
- 4) The Error Check field

- **Address Field**

The address field is 1-byte long and identifies which slave device the packet is for. Valid addresses range between 1 and 247. The slave device whose address matches the value in this field will perform the command specified in the packet.

- **Function Field**

The function field is 1-byte long and tells the addressed slave which function to



perform. Slave response packet should include same function field byte as request. The Modbus functions supported by SPM33 are listed as below:

Function Code	Meaning	Action
0x01	Read Relay Output Status	Obtains ON/ OFF information of one or more relay output in SPM33 (0/1)
0x03	Read Holding Registers	Obtains the current value in one or more holding registers of the SPM33.
0x05	Relay control	Write 0xFF00 to close (ON) the relay Write 0x0000 to open (OFF) the relay
0x10	Preset Multiple Registers	Places specific binary values into a series of consecutive holding registers of the SPM33

- **Data Field**

The length of Data Field is varies in length depending on its function. In general, MODBUS supports "BIG INDIAN" mode, it means high-order byte first, low-order byte second.

For example,

One 16 byte register value is 0x12AB; register is transmitted in below sequence:

High-order byte = 0x12

Low-order byte = 0xAB

- **Error Check Field**

In Modbus RTU mode, the 16-bit Cyclic Redundancy Check (CRC-16) is used. The sending device calculates a 16-bit value, based on the information stored in the address, function and data fields using the CRC-16 algorithm and appends it to the end of the packet. The receiving device performs the same calculation upon the reception of a packet. If the result does not match the checksum stored in the packet, transmission errors have occurred and the packet will be ignored by the receiving device.

For detail of CRC16 parity arithmetic, please refer to Section 4 .

8.2.4. Abnormal Responses

If a Modbus master device sends a non-effective command to a SPM33 or attempts to read a non-effective holding register, an exception response will be generated. The exception response consists of the slave address, function code, error code, and error check field. The high order bit of the function code is set to 1 to indicate that the packet is an exception response.



Below list describes the meanings of exception codes:

Function Code	Meaning
01 illegal function code	SPM33 Modbus support the function code include: 01H, 02H, 03H, 05H, and 10H. This code means the slave device receive an illegal function code, or the SPM33 receive the error command.
02 illegal function code	SPM33 receive the address referenced in the data field is an invalid address.
03 illegal function code	The requested register number is too long.

8.2.5. Broadcast Packets

SPM33 support broadcast commands when communicating in MODBUS mode.

Do write command 0x10 for timing.

8.3. Packet Communication

Two MODBUS functions are supported by the SPM33. The standard MODBUS protocol supports only 16-bit registers, which limit the maximum value of any measurement to 65535.

Section 3.1 will describe the format of Read/ Response Packet of relay output.

Section 3.2 will describe the format of Read/ Response Packet of holding register.

Section 3.3 will describe the relay control command

Section 3.4 will describe Preset Multiple Registers packet and the acknowledge packet.

8.3.1 Read the Relay Output Status (Function Code 01H)

Use 01 command to read the relay status. Relays are addressed starting at 0: relay 1 is addressed as 0.

The relay status data in response packet is packed as one bit for one relay. 1= ON, 0 = OFF.

The LSB (Least Significant Bit) of the first data byte contains the request addressing output. Other relay is same as this, until to the high bit of this byte, and rank from low bit to high bit in the followed byte.

If the return output Num. is not a multiple of 8, it will use zero to fill in the



remainder bit of last data byte (until to the high bit of the byte). The byte count field specifies all byte num. of the data.

Request Packet (Master→SPM33)		Response Packet (SPM33→Master)	
Unit ID/ Slave address	1 byte	Unit ID/ Slave address	1 byte
01H (Function Code)	1 byte	01H (Function Code)	1 byte
Starting address	2 bytes	Byte num. (N)	1 byte
Relay num.	2 bytes	Relay status	N bytes
CRC check code	2 bytes	CRC check code	2 bytes

N = output num. ÷ 8, if remainder ≠ 0, then N=N+1.

8.3.2. Read Holding Registers (Function Code 03H)

This command packet requests that the SPM33 responds all valid registers.

The value of reserved registers is 0.

Request Packet (Master→SPM33)		Response Packet (SPM33→Master)	
Unit ID/ Slave address	1 byte	Unit ID/ Slave address	1 byte
03 H (Function Code)	1 byte	03 H (Function Code)	1 byte
Start register address	2 bytes	Byte num. (2 * register num.)	1 byte
Registers num.	2 bytes	First register data	2 bytes
CRC check code	2 bytes	Second register data	2 bytes
		
		CRC check code	2 bytes



8.3.3 Relay Control (Function Code 05H)

Use 05 command to control the relay. Relays are addressed starting at 0

Data Field is 0xFF00, request the relay to be ON.

Data Field is 0x0000, request the relay to be OFF.

Request Packet (Master→SPM33)		Response Packet (SPM33→Master)	
Unit ID/ Slave address	1 byte	Unit ID/ Slave address	1 byte
05 H (Function Code)	1 byte	05 H (Function Code)	1 byte
Start register address	2 bytes	Start register address	2 bytes
Data field	FF	Data field	FF
Data field	00	Data field	00
CRC check code	2 bytes	CRC check code	2 bytes

8.3.4. Preset Multiple Registers (Function code 10H)

Preset Registers Format (Master→SPM33)		Response Format (SPM33→Master)	
Unit ID/ Slave address	1 byte	Unit ID/ Slave address	1 byte
10 H (Function Code)	1 byte	10 H (Function Code)	1 byte
Start register address	2 bytes	Start register address	2 bytes
Register num.	2 bytes	Register num.	2 bytes
Byte num. (2 * register num.)	1 byte	CRC check code	2 bytes
First register data			
Second register data			
...			
CRC check code	2 bytes		

This command packet allows the Master to program the SPM33 setup parameters.

Note: SPM33 presume all registers are continuous from the first one.



8.4. Calculating the CRC-16 Error Check Field

This section describes the procedure for obtaining the CRC-16 error check field. A packet can be considered as a continuous, serial stream of binary data (0, 1). The 16-bit checksum is obtained by multiplying the serial data stream by 216 (1000000000000000) and then dividing it by the **generator polynomial** $x^{16}+x^{15}+x^2+1$, which can be expressed as a binary data 11000000000000101. The quotient is ignored and the 16-bit remainder is the checksum and is appended to end of the packet.

In calculating the CRC, all arithmetic operations (additions and subtractions) are performed using MODULO TWO, or EXCLUSIVE OR operation.

Steps for the Generating the CRC-16 Checksum:

- 1) Form a new polynomial by dropping the MSB (Most Significant Bit) of the generator polynomial and reversing the bit sequence. This yields the binary number 1010 0000 0000 0001 or A0 01 Hex.
- 2) Load a 16-bit register with initial value FF FF Hex.
- 3) Exclusive OR the first data byte with the loworder byte of the 16-bit register, storing the result in the 16-bit register.
- 4) Shift the 16-bit register one bit to the right. If overflow bit is 1, then turn to step 5). Otherwise, turn to step 6)
- 5a) If the bit shifted out to the right is one, Exclusive OR the 16-bit register with

the new generator polynomial, with result stored in the 16-bit register. Return to step 4.

5b) If the bit shifted out to the right is zero, return to step 4.

6) Repeat steps 4 and 5 until 8 shifts have been performed.

7) Exclusive OR the next data byte with the 16-bit register.

8) Repeat steps 4 through 7 until all bytes of the packet have been calculate by XOR

9) The content of the 16-bit register is CRC-16

Procedure for Calculating the 6403 Bytes of 16 Hex.

Step	Byte	Action	Register	Bit#	Shift
2		Initial Value	1111 1111 1111 1111		
	1	Load the first byte	0000 0000 0110 0100		
3		XOR	1111 1111 1001 1011		
4		SHIFT 1 bit to the right	0111 1111 1100 1101	1	1
5a		XOR polynomial	1101 1111 1100 1100		
4		SHIFT 1 bit to the right	0110 1111 1110 0110	2	0
4		SHIFT 1 bit to the right	0011 0111 1111 0011	3	0
4		SHIFT 1 bit to the right	0001 1011 1111 1001	4	1



5a		XOR polynomial	1011 1011 1111 1000		
4		SHIFT 1 bit to the right	0101 1101 1111 1100	5	0
4		SHIFT 1 bit to the right	0010 1110 1111 1110	6	0
4		SHIFT 1 bit to the right	0001 0111 0111 1111	7	0
4		SHIFT 1 bit to the right	0000 1011 1011 1111	8	1
5a		SHIFT 1 bit to the right	1010 1011 1011 1110		
	2	Load the second byte	0000 0000 0000 0011		
7		XOR	1010 1011 1011 1101		
4		SHIFT 1 bit to the right	0101 0101 1101 1110	1	1
5a		XOR polynomial	1111 0101 1101 1111		
4		SHIFT 1 bit to the right	0111 1010 1110 1111	2	1
5a		XOR polynomial	1101 1010 1110 1110		
4		SHIFT 1 bit to the right	0110 1101 0111 0111	3	0

4		SHIFT 1 bit to the right	0011 0110 1011 1011	4	1
5a		XOR polynomial	1001 0110 1011 1010		
4		SHIFT 1 bit to the right	0100 1011 0101 1101	5	0
4		SHIFT 1 bit to the right	0010 0101 1010 1110	6	1
5a		XOR polynomial	1000 0101 1010 1111		
4		SHIFT 1 bit to the right	0100 0010 1101 0111	7	1
5a		XOR polynomial	1110 0010 1101 0110		
4		SHIFT 1 bit to the right	0111 0001 0110 1011	8	0
		CRC-16	0111 0001 0110 1011		



8.5. Description of SPM33 Registers

All SPM33 measured and setup parameters are treated as HOLDING REGISTERS having addresses **4xxxx** when communicating in MODBUS protocol. According to the MODBUS Protocol, in response to a request for register **4xxxx** of a particular slave device (SPM33), the MODBUS master reads register **xxxx-1** from the slave (SPM33). For example register 40011 corresponds to register 10.

8.6 Description of Data Types

UINT16	Unsigned 16-digit integer
INT16	Signed 16-digit integer
LUINT32	Unsigned 32-digit integer
LINT32	Signed 32-digit integer
WORD16	<p>Bit denotation word, applicable to on-off and relay status.</p> <p>D0 refers to the first on-off or relay channel.</p> <p>D1 refers to the second on-off or relay channel.</p> <p>The rest bits may be deduced by analogy.</p> <p>Bit 0 refers to "off", and bit 1 refers to "on".</p>

8.6.1 Real-time data register list

Register address	Read/write attribute	Definition	Data Type	Description
40001	RO	Phase A voltage	UINT16	Secondary side L-N voltage, Calculation factor: 0.01, unit: V
40002	RO	Phase B voltage		
40003	RO	Phase C voltage		
40004	RO	Line AB voltage	UINT16	Secondary side L-L voltage, Calculation factor: 0.01, unit: V
40005	RO	Line BC voltage		
40006	RO	Line CA voltage		
40007	RO	Phase A current	UINT16	Secondary Side current, Calculation factor: 0.001, unit: A. If use CT, then customers need to multiply by CT ratio.
40008	RO	Phase B current		
40009	RO	Phase C current		
40010	RO	Neutral current		
40011	RO	Total active power low word	LINT32	Secondary side active



40012	RO	Total active power high word		power. Calculation factor: 0.1, unit: W. If use CT, then customers need to multiply by CT ratio.
40013	RO	Total reactive power low word	LINT32	Secondary side reactive power. Calculation factor: 0.1, unit: var. If use CT, then customers need to multiply by CT ratio.
40014	RO	Total reactive power high word		
40015	RO	Total power factor	INT16	
40016	RO	Phase A active power	INT16	Secondary side active power. Calculation factor: 0.1, unit: W. If use CT, then customers need to multiply by CT ratio. Only when it is 3 phase 4 wires connection mode can the value valid.
40017	RO	Phase B active power		
40018	RO	Phase C active power		
40019	RO	Phase A reactive power	INT16	Secondary side reactive power. Calculation

40020	RO	Phase B reactive power		factor: 0.1, unit: W. If use CT, then customers need to multiply by CT ratio. Only when it is 3 phase 4 wires connection mode can the value valid.
40021	RO	Phase C reactive power		
40022	RO	Phase A power factor	INT16	Calculation factor: 0.001. Only when it is 3 phase 4 wires connection mode can the value valid.
40023	RO	Phase B power factor		
40024	RO	Phase C power factor		
40025	RO	Frequency	UNIT16	Calculation factor: 0.01, unit: Hz
40026	RO	Total active energy low word	LUINT3 2	Calculation factor: 0.1, unit: kWh Range: 0-99,999,999.9
40027		Total active energy high word		
40028	RO	Total reactive energy low word	LUINT3 2	Calculation factor: 0.1, unit: kvarh Range: 0-99,999,999.9
40029		Total reactive energy low word		



40030	RO	Input active energy low word	LUINT3 2	Calculation factor: 0.1, unit: kWh Range: 0-99,999,999.9
40031		Input active energy high word		
40032	RO	Output active energy low word	LUINT3 2	Calculation factor: 0.1, unit: kWh Range: 0-99,999,999.9
40033		Output active energy high word		
40034	RO	Input reactive energy low word	LUINT3 2	Calculation factor: 0.1, unit: kvarh Range: 0-99,999,999.9
40035		Input reactive energy high word		
40036	RO	Output reactive energy low word	LUINT3 2	Calculation factor: 0.1, unit: kvarh Range: 0-99,999,999.9
40037		Output reactive energy high word		
40038	RO	On-off status	WORD1	D0 means 1 channel

			6	D1 means 2 channel
40039	RO	Relay status		0 means off 1 means on
40040	RO	Alarm status	WORD1 6	1 means alarm, 0 means no alarm Bit 1: over voltage Bit 2: under voltage Bit 3: over current Bit 4: under current Bit 5: Frequency too high Bit 6: Frequency too low Bit 7: over load Bit 8: phase loss Bit 9: Status 1 off
40041	RO	CT Ratio		
40042	RO	Reserved		
40043	RO	Average phase voltage	UINT16	Calculation factor: 0.01, unit: V



40044	RO	Average line voltage		Calculation factor: 0.01, unit: V
40045	RO	Average phase current	UINT16	Calculation factor: 0.001, unit: A
40046	RO	Current unbalance rate		Calculation factor: 0.001
40047	RO	Phase A apparent power	UINT16	Calculation factor: 0.1, unit: VA
40048	RO	Phase B apparent power		
40049	RO	Phase C apparent power		
40050	RO	Total apparent power low word	LUINT3 2	
40051		Total apparent power high word		
40052	RO	Grid Input Active Power		Primary measurement Power, calculator factor 0.1, unit: kWh First is low byte, second is high byte Range: 0-99,999,999.9
40053				
40054	RO	Grid Output Active Power		Primary measurement Power,

40055			<p>calculator factor 0.1, unit: kWh</p> <p>First is low byte, second is high byte</p> <p>Range: 0-99,999,999.9</p>
40056	RO	Grid total Active Power	<p>Primary measurement Power,</p> <p>calculator factor 0.1, unit: kWh</p> <p>First is low byte, second is high byte</p> <p>Range: 0-99,999,999.9</p>
40057			
40058	RO	Grid Input Reactive Power	<p>Primary measurement Power,</p> <p>calculator factor 0.1, unit: kvarh</p> <p>First is low byte, second is high byte</p> <p>Range: 0-99,999,999.9</p>
40059			
40060	RO	Grid Output Reactive Power	<p>Primary measurement Power,</p> <p>calculator factor 0.1, unit: kvarh</p> <p>First is low byte, second is high byte</p> <p>Range: 0-99,999,999.9</p>
40061			
40062	RO	Grid total Reactive Power	<p>Primary measurement Power,</p> <p>calculator factor 0.1, unit: kvarh</p> <p>First is low byte, second is high byte</p>
40063			



			Range: 0-99,999,999.9
40064	RO	Generator Input Active Power	Primary measurement Power, calculator factor 0.1, unit: kWh First is low byte, second is high byte
40065			Range: 0-99,999,999.9
40066	RO	Generator Output Active Power	Primary measurement Power, calculator factor 0.1, unit: kWh First is low byte, second is high byte
40067			Range: 0-99,999,999.9
40068	RO	Generator total Active Power	Primary measurement Power, calculator factor 0.1, unit: kWh First is low byte, second is high byte
40069			Range: 0-99,999,999.9
40070	RO	Generator Input Reactive Power	Primary measurement Power, calculator factor 0.1, unit: kvarh First is low byte, second is high byte
40071			Range: 0-99,999,999.9
40072	RO	Generator Output Reactive	Primary measurement Power,

40073		Power	calculator factor 0.1, unit: kvarh First is low byte, second is high byte Range: 0-99,999,999.9
40074	RO	Generator total Reactive	Primary measurement Power, calculator factor 0.1, unit: kvarh First is low byte, second is high byte Range: 0-99,999,999.9
40075		Power	
40076	RO	Ferroelectric fault register	Factory using 0: Normal 1. Abnormal
40077	RO	Inside REF sampling real time value	



8.6.2 List of demand data registers

Register address	Read/write attribute	Definition	Data type	Description
40701	RO	Phase A current demand	UINT16	Calculation factor: 0.001, unit: A
40702	RO	Phase B current demand		
40703	RO	Phase C current demand		
40704	RO	Phase A active power demand	UINT16	Calculation factor: 0.1, unit: W
40705	RO	Phase B active power demand		
40706	RO	Phase C active power demand		
40707	RO	Total active power demand low word	LINT32	Calculation factor: 0.1, unit: W
40708		Total active power demand high word		
40709	RO	Maximum phase A current demand	UINT16	Calculation factor: 0.001, unit: A
40710	RO	Maximum phase B current demand		
40711	RO	Maximum phase C current demand		
40712	RO	Maximum phase A active power		Calculation factor:

		demand	UINT16	0.1, unit: W
40713	RO	Maximum phase B active power demand		
40714	RO	Maximum phase C active power demand		
40715	RO	Total active power demand low word	LUINT3 2	Calculation factor: 0.1, unit: W
40716		Total active power demand high word		
40717	RO	Phase A reactive power demand	10 times, unit: var	
40718	RO	Phase B reactive power demand	10 times, unit: var	
40719	RO	Phase C reactive power demand	10 times, unit: var	
40720	RO	Total reactive power demand	10 times, unit: var	
40721				
40722	RO	Phase A apparent power demand	10 times, unit: VA	
40723	RO	Phase B apparent power demand	10 times, unit: VA	
40724	RO	Phase C apparent power demand	10 times, unit: VA	



40725	RO	Total apparent power demand	10 times, unit: VA
40726			
40727	RO	Phase A reactive power Maximum demand	10 times, unit: var
40728	RO	Phase B reactive power Maximum demand	10 times, unit: var
40729	RO	Phase C reactive power Maximum demand	10 times, unit: var
40730	RO	Total reactive power Maximum demand	10 times, unit: var
40731			
40732	RO	Phase A apparent power Maximum demand	10 times, unit: VA
40733	RO	Phase B apparent power Maximum demand	10 times, unit: VA
40734	RO	Phase C apparent power Maximum demand	10 times, unit: VA
40735	RO	Total apparent power Maximum demand	10 times, unit: VA

8.6.3 List of harmonic data registers

Register address	Read/write attribute	Definition	Data type	Description
40801	RO	Va - THD	UINT16	Calculation factor: 0.001
40802	RO	Vb - THD		
40803	RO	Vc - THD		
40804	RO	Ia - THD	UINT16	Calculation factor: 0.001
40805	RO	Ib - THD		
40806	RO	Ic - THD		
40807	RO	2nd harmonic component of Va	UINT16	Calculation factor: 0.001, Unit: %
40808	RO	3rd harmonic component of Va		



40809	RO	...		
-40835				
40836	RO	31st harmonic component of Va		
40837	RO	2nd harmonic component of Vb	UINT16	Calculation factor: 0.001, Unit: %
40838	RO	3rd harmonic component of Vb		
40839	RO	...		
-40865				
40866	RO	31st harmonic component of Vb		
40867	RO	2nd harmonic component of Vc	UINT16	Calculation factor: 0.001, Unit: %
40868	RO	3rd harmonic component of Vc		
40869	RO	...		
-40895				
40896	RO	31st harmonic component of Vc		
40897	RO	2nd harmonic component of Ia	UINT16	Calculation factor: 0.001, Unit: %
40898	RO	3rd harmonic component of Ia		
40899	RO	...		
-40925				

40926	RO	31st harmonic component of Ia		
40927	RO	2nd harmonic component of Ib	UINT16	Calculation factor: 0.001, Unit: %
40928	RO	3rd harmonic component of Ib		
40929	RO	...		
-40955				
40956	RO	31st harmonic component of Ib		
40957	RO	2nd harmonic component of Ic	UINT16	Calculation factor: 0.001, Unit: %
40958	RO	3rd harmonic component of Ic		
40959-40985	RO	...		
85				
40986	RO	31st harmonic component of Ic		Calculation factor: 0.001, Unit: %



8.6.4 List of configuration registers

Register address	R&W attribute	Definition	Description
40201	RW	Communication Address	1--247
40202	RW	CT ratio	1--10000
40203	RW	Connection mode	0--1 0 : 3 phase 4 wire 1: 3 phase 3 wire
40204	RO	Reserved	Read only
40205	RO	Reserved	Read only
40206	RW	Baud rate	0--1 0: 4800 1: 9600
40207	RO	Reserved	Read only
40208	RO	Reserved	Read only
40209	RO	Reserved	Read only

40210	RW	<p>Current Channel of 1st</p> <p>Voltage mapping</p>	<p>Default 1, 1st forward current</p> <p>1 means 1st forward current</p> <p>2 means 2nd forward current</p> <p>3 means 3rd forward current</p> <p>0x8001 means 1st reverse current</p> <p>0x8002 means 2nd reverse current</p> <p>0x8003 means 3rd reverse current</p>
40211	RW	<p>Current Channel of 2nd</p> <p>Voltage mapping</p>	<p>Default 2, 2nd forward current</p> <p>1 means 1st forward current</p> <p>2 means 2nd forward current</p> <p>3 means 3rd forward current</p> <p>0x8001 means 1st reverse current</p> <p>0x8002 means 2nd reverse current</p> <p>0x8003 means 3rd reverse current</p>
40212			<p>Default 3, 3rd forward current</p> <p>1 means 1st forward current</p>



	RW	Current Channel of 3 rd Voltage mapping	2 means 2 nd forward current 3 means 3 rd forward current 0x8001 means 1 st reverse current 0x8002 means 2 nd reverse current 0x8003 means 3 rd reverse current
40213	RW	Working status of relay 1	0—1, default 0, remote 0 means remote control 1 means auto alarm
40214	RW	Return time of relay 1	Default 0 0~120 (s) 0 means blocking.
40215	RW	Working status of relay 2	0—1, default 0, remote 0 means remote control 1 means auto alarm
40216	RW	Return time of relay 2	Default 0 0~120 (s) 0 means blocking.
40217		Reserved	

40218		Reserved	
40219		Reserved	
40220		Reserved	
40221	RW	Operation value of voltage upper limit	Calculation factor: 0.01, Unit:V 0 means closed For 110V – 500V, default 0.
40222	RW	Action time of voltage upper limit	0-120s.
40223	RW	Operation value of voltage lower limit	Calculation factor: 0.01, Unit:V 0 means closed For 110V – 500V, default 0.
40224	RW	Action time of voltage lower limit	0-120s.
40225	RW	Operation value of current upper limit (low word)	Primary value of current. Calculation factor: 0.1, Unit: A 0 means closed
40226		Operation value of current upper limit (high word)	1.0A-60000.0A



		word)	
40227	RW	Action time of voltage upper limit	0-120s
40228	RW	Operation value of current lower limit (low word)	Primary value of current. Calculation factor: 0.1, Unit: A 0 means closed 1.0A-60000.0A
40229		Operation value of current lower limit (high word)	
40230	RW	Action time of voltage lower limit	0-120s
40231	RW	Operation value of frequency upper limit	Calculation factor: 0.01, Unit: Hz 0 means closed 45Hz – 65Hz
40232	RW	Action time of frequency upper limit	0-120s

40233	RW	Operation value of frequency lower limit	Calculation factor: 0.01, Unit: Hz 0 means closed 45Hz – 65Hz
40234	RW	Action time of frequency lower limit	0-120s
40235	RW	Operation value of active power upper limit (low word)	Primary side value Calculation factor: 0.1, Unit: kW
40236		Operation value of active power upper limit (high word)	0.1-40000.0kW
40237	RW	Action time of active power upper limit	0-120s
40238	RW	Setting for phase loss alarm	0 means closed 1 means open When phase A or phase B < 110V, it means phase loss.



			When phase A, phase B and phase C all < 110V, it means work normal.
40239	RW	Alarm status	0 means closed 1 means open.

Note: Register 40221—40239 should be set once time. What's more, the upper limit must higher than lower limit.

8.6.5 Register for command and clear energy

Register address	Read/write attribute	Data type	Definition	Description
40252	WO	U16	Clear Maximum value of demand	Write 888
40253	WO	U16	Clear energy	Write 78
40254	WO	U32	Input active energy	Calculation factor: 0.1, Unit: kWh
40255				
40256	WO	U32	Output active energy	
40257				
40258	WO	U32	Input reactive	Calculation factor: 0.1,

40259			energy	Unit: kvarh
40260	WO	U32	Output reactive	
40261			energy	

Note: Register 40254~40261 should be read /write once time

8.6.6 List of device information registers

Register address	Read/write attribute	Definition	Description
49001	RW	Device No.	
49002			
49003	WO	Recover user system	Write 888
49004	WO	Recover factory setting	Write 888
49005	RO	Firmware version	1.0.5 <Main version>.<Sub version>.<modify version>
49006	RO	Hardware version	1.0.5 <Main version>.<Sub version>.<modify version>

9. Maintenance and Trouble Shooting

Possible problem	Possible cause	Possible solution
There is no display on device after impose power supply.	The power supply fails to be imposed on the meter.	<p>Check if the correct working voltage has been imposed on the L/+ and N/- terminals of the meter.</p> <p>Check if the fuse for the control power supply has been burnt down.</p>
The measured value is not correct or does not conform to the expectation.	The voltage measurement is not correct.	<p>Check if the neutral point has been connected reliably.</p> <p>Check if the measured voltage matches the rated parameter of the meter.</p> <p>Check if the PT ratio has been set correctly.</p>
	The current measurement is not correct.	Check if the measured current matches the rated parameter of the meter.

		Check if the CT ratio has been set correctly.
	The power measurement is not correct.	<p>Check if the measurement mode has been set correctly.</p> <p>Check if the phase sequence corresponding to the voltage and the current is correct.</p> <p>Check if the current terminals of the same name are wrong.</p>
The digital input status no changing.	The voltage relating to digital input is not correct.	<p>Check if the types of external nodes match the rated parameters of the meter.</p> <p>Check if the external connection is correct.</p>
The relay output status no changing.	The relay does not receive the control command.	Check if the communication link is correct.
	The control mode of relay	Check if the current relay is under the



	is not correct.	correct mode.
There is no communication between the upper end device and the meter	The communication baud rate of the meter is not correct.	Check if the communication baud rate of the meter is consistent with its definition.
	The communication link has not been connected to the terminal resistor.	Check if the 120-Ohm resistor has been connected.
	The communication link suffers interference.	Check if the communication-shielding layer has been earthed effectively.
	The communication line is interrupted.	Check if the communication cable has been disconnected.
	The communication baud rate of the meter is not correct.	Check if the communication baud rate of the meter is consistent with its definition.

10. Appendix 1

10.1 Terminals Definition

No.	Definition	Instruction	No.	Definiton	Instruction
1	L/+	Positive pole of power supply	2	NC	Null
3	N/-	Negative pole of power supply	4	NC	Null
5	S1	Status input 1	6	S2	Status input 2
7	SG	Status input public GND	8	RL1	Relay 1 output 1
9	RLN1	Relay 1 Output 2	10	RL2	Relay 2 Output 1
11	RLN2	Relay 2 Output 2	12	RS485 -	485 positive pole
13	RS485+	485 positive pole	14	SHLD	RS485 shield
15	VA	phase A voltage	16	VB	phase B voltage
17	VC	phase C voltage	18	VN	Neutral line
19	I11	Phase A current incoming line	20	I12	Phase A current outgoing line
21	I21	Phase B current incoming line	22	I22	Phase B current outgoing line
23	I31	Phase C current incoming line	24	I32	Phase C current outgoing line

10.2 Typical Connection

SPM33 supports multiple connection modes of measurement, the following methods were used icons explained.

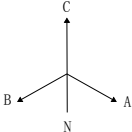
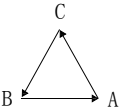
	
<p>Vector of three-phase four-wire system</p>	<p>Vector of three-phase three-wire system</p>

■ three-phase four-wire system :

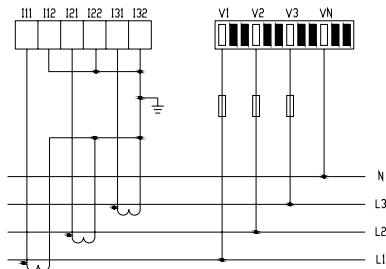

■ three-phase three-wire system , 3CT :

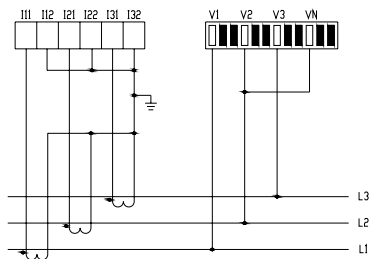

■ three-phase three-wire system , 2CT :

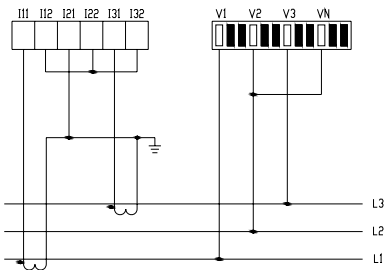

SPM33 typical wiring diagrams, comprehensive electrical parameters measuring under three-phase four-wire mode, with digital status inputs and one RS485 communication function:

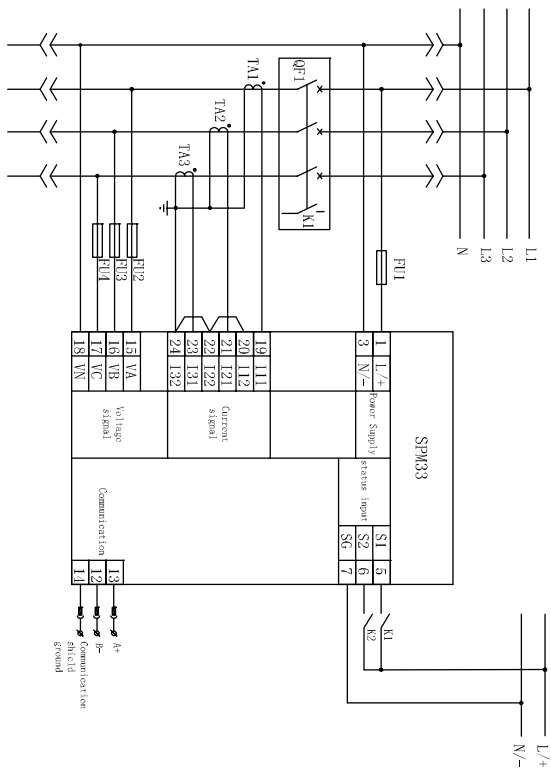

Notice:

- PILOT reserves the right to modify this manual without prior notice in view of continued improvement.
- Technical Consulting: +86 15916202620
- After-sale Services: +86 15916202800
- Email: pilot006@pmac.com.cn

Pilot
