

PMAC615 Single Phase Digital Panel Meter

Installation & Operation Manual

V1.0



ZHUHAI PILOT ELECTRONICS CO., LTD.



Danger and warning!

This device can be installed only by professionals.

The manufacturer shall not be held responsible for any accident caused by the failure to comply with the instructions in this manual.



Risks of electric shocks, burning, or explosion

- This device can be installed and maintained only by qualified people.
- Before operating the device, isolate the voltage input and power supply and short-circuit the secondary windings of all current transformers.
- Put all mechanical parts, doors, or covers in their original positions before energizing the device.
- Always supply the device with the correct working voltage during its operation.

Failure to take these preventive measures could cause damage to equipment or injuries to people.

CONTENTS

1. Product Description.....	4
2. Installation and Connection.....	6
3. Order Information.....	9
4. Measurement Performance.....	10
5. Operation.....	13
6. Input/ Output Characteristics.....	18
7. Setpoint Alarm.....	20
8. Communication Protocol.....	22
9. Maintenance and Trouble Shooting.....	29
10. Technical Datasheet.....	31

1. Product Description

PMAC615 digital panel meter is designed for single-phase measurements of AC power signals and related parameters. Instead of traditional pointer meters, relay and other components, PMAC615 digital panel meter integrates sampling and control function, which is suitable for various low voltage single phase system.

PMAC615 digital panel meter provides an optional RS485 communication port to link with PLC, PCs and SCADA system. Users can program the parameter via RS485 COM easily.

PMAC615 digital panel meter is made by complicate frequency locking technology which supports up to 0.2% high accuracy measurements for non-linear load. Users may read the measurement value from LED panel or via software.

Besides, PMAC615 provides optional two status inputs, one relay output for different application. User can choose the DI/ DO flexibly. And its pluggable terminals connection is easy for local wiring or maintain.

1.1 View

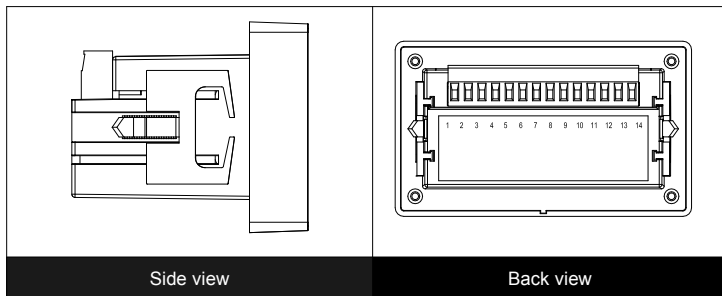

1.2 Features

The main features of PMAC615 are below:

- ◆ Accept standard CT input
- ◆ Direct connect to max. 400V voltage system
- ◆ Active energy accuracy is in accordance with IEC62053-21, class 1
- ◆ Accuracy of voltage and current measurement is 0.2%
- ◆ Friendly LED panel for reading
- ◆ Revisable relay alarm output
- ◆ Optional two status input
- ◆ Pluggable terminals, easy for wiring and maintain
- ◆ RS485 communication, support standard MODBUS-RTU protocol
- ◆ Operating temperature: -20°C - +60°C
Storage temperature: -30°C - +70°C
Humidity: 5% - 90%RH, non-condensing

2. Installation and Connection

2.1 Environment

Operating temperature: -20°C - $+60^{\circ}\text{C}$

Storage temperature: -30°C - $+70^{\circ}\text{C}$

Humidity: 5% - 90%RH, non-condensing

2.2 Dimension

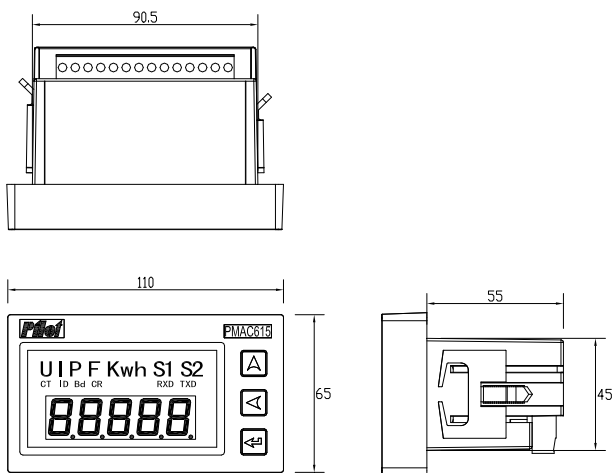

2.3 Terminals Instruction

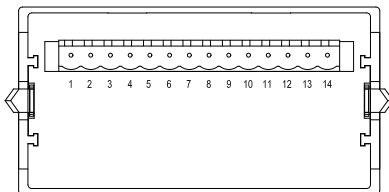

No.	Mark	Definition
1	N/-	Null line
2	L/+	Live line
3	I-	Current negative pole
4	I+	Current positive pole
5	V-	Voltage negative pole
6	V+	Voltage positive pole
7	485+	RS485 positive pole
8	485-	RS485 negative pole
9	S1+	Status input 1 positive pole
10	S1-	Status input 1 negative pole
11	S2+	Status input 2 positive pole
12	S2-	Status input 2 negative pole
13	RL+	Relay output positive pole
14	RL-	Relay output negative pole

2.4 Connection

Example: PMAC615-I-SRC single phase digital current meter, provides one RS485, two status input and one relay output.

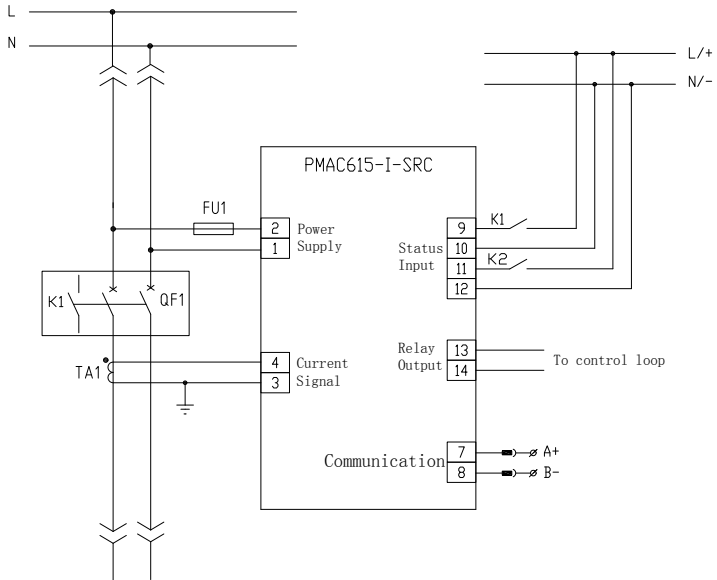

3. Order Information

Definition of full model number of PMAC615 as following sheet:

Model number: PMAC615- ①- ②	
① : Module Structure	
U	Voltage
I	Current
P	Voltage + Current + Active Power
W	Voltage + Current + Active Energy
Z	Voltage + Current + Active Power + Reactive Power + Power Factor + Frequency + Active Energy
② : Auxiliary Function	
S	Two Status Input (external power supply)
RC	One Relay Output + One RS485 Communication
C	One RS485 Communication

Note:

1. Default rated current is 5A. Other customized feature is available, please mention requirement when place order.
2. Reactive power and power factor can be read via RS485 COM only

Example: In case the model number is PMAC615-I-S, the corresponding feature is measuring current, providing two status input, rated current is 5A.

4. Measurement Performance

4.1 Real-time Measurement

PMAC615 provide real-time measurement of voltage, current, power and so on. Below data is true RMS. The update rate is 1 second.

Real-time Reading	Measuring Range
Current	0 – 50,000A
Voltage	0 – 500V
Active Power / Reactive Power	0 - ± 30MW/Var
Power Factor	-1.000 - +1.000
Frequency	45Hz - 65Hz
Active Energy	0 - 99,999,999.9 kWh

Note: The value of reactive power and power factor is read from RS485 COM.

4.2 Symbol of Power Factor

The measurement of power factor symbol by PMAC615 is according to IEC standard, as follow instruction:

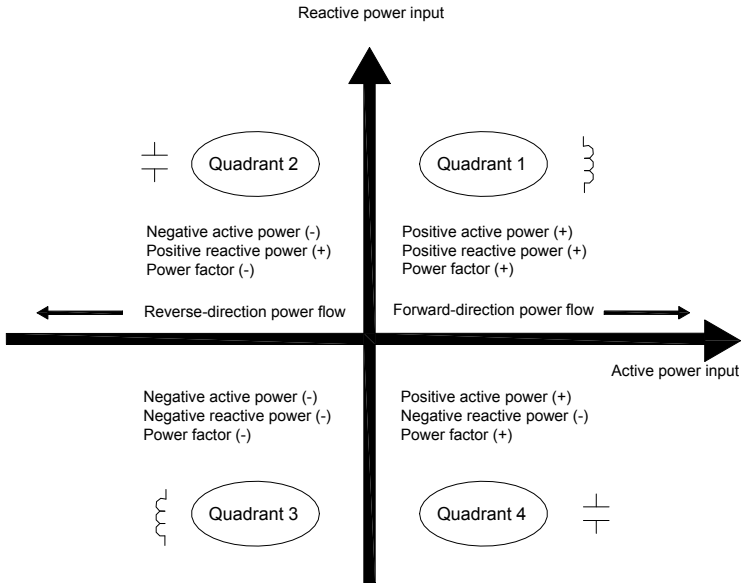

4.3 Energy Parameter

PMAC615 provides measurement of bidirection active energy, up to 99,999,999.9 kWh. Due to the limitation of LED window size, the meter displays one energy data into two times. It firstly displays the 5th digit and above in front of decimal point, secondary displays the rest below thousand's digit (include thousand's digit).

When the accumulated energy reaches 99,999,999.9 kWh, the value will turnover automatically.

The symbol of energy vary with power. In accordance with IEC Standard, the related definition please refer to Charter 4.2 ***Symbol of Power Factor.***

The sheet below describes the interrelationships of various types of energy and the symbolic relationships between energy and power:

Input active energy	First-quadrant active energy	Positive inductive active power
	Fourth-quadrant active energy	Positive capacitive active power
output active energy	Second-quadrant active energy	Negative capacitive active power
	Third-quadrant active energy	Negative inductive active power

5. Operation

5.1 Display

<p>Display instruction</p> <p>A: Communication prompt</p> <p>B: Data area</p> <p>C: Status input prompt</p> <p>D: Programming menu prompt</p> <p>E: Real-time parameter data</p> <p>1: Logo</p> <p>2: Model No.</p>	
---	--









Key-press instruction: the function of every key vary with interface.

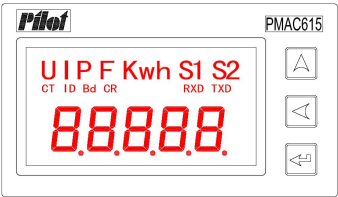

	Data display interface	Programming interface	
		Configure viewing	Configure modifying
	Page turning in submenu.	Quit viewing	Move cursor
	Page turning in main menu.	Page turning on menu	Modify the value on cursor's digit
	Enter into configure viewing	Enter into programming interface.	Confirm the modification

5.2 Data Viewing

The real-time measured data is displayed in form of following menu. If the meter is not a full function device, the relating display is missing.

The procedure of real-time data viewing is as follow:

	<p>The initial power-up interface of the meter is shown as follow:</p> 
<p>Press key  continuously, it displays measurement data one by one.</p>	<p>Voltage</p> 
<p>Press key  once, it displays measurement value of current</p>	<p>Current</p> 
<p>Press key  once, it displays measurement value of active power. (Reactive power and power factor shall be read via communication)</p>	<p>Active Power</p> 
<p>Press key  once, it displays measurement value of frequency.</p>	<p>Frequency</p> 

<p>Press key  once, it displays measurement value of active energy, firstly displays the data above 10000' digit.</p>	<p>Active Energy \geq 10000' digit, with a mark "H"</p> <div data-bbox="570 173 798 305" style="border: 1px solid black; padding: 10px; text-align: center;"> <p>Kwh</p> <p>H 257</p> </div>
<p>Press key  once, it displays the active energy value in 1000' digit.</p>	<p>Active Energy $<$ 10000' digit</p> <div data-bbox="576 354 795 480" style="border: 1px solid black; padding: 10px; text-align: center;"> <p>Kwh</p> <p>730.16</p> </div>

Note: Above data is just for reference, there is no logical relation.





















5.3 Parameter Viewing







1. State of Status Input: S indicates Status. Number 1, 2 indicates the corresponding channel. If the character on LED lights on, it means the channel is closed. Otherwise, the channel is open.
2. Communication State: The communication light has two kinds of character: "RXD" indicates "Receiving", and "TXD" indicates "Sending". When the corresponding character flashes, that means there is data flow. Users will know the communication state according to the character on LED. If "RXD" flashes, it means receiving data. If "TXD" flashes, it means sending data. If there is no communication, no character flash.

5.4 Parameter Setting

For setting the parameter, please refer to following procedure.

Press key  , enter into configuration interface.

<ol style="list-style-type: none"> 1. Press key  until to CT character. 2. Press key , a cursor appears. 3. Press key , change the value. 4. Press key , confirm the new value, the cursor disappears. 	<p>Set CT ratio (Current Transformer)</p> 
<ol style="list-style-type: none"> 1. Press key  until to ID character. 2. Press key , a cursor appears. 3. Press key , change the value. 4. Press key , confirm the new value, the cursor disappears. 	<p>Set Communication Address</p> 
<ol style="list-style-type: none"> 1. Press key  until to Bd character. 2. Press key , a cursor appears. 3. Press key , select 4800 or 9600. 4. Press key , confirm the selection, the cursor disappears. 	<p>Set Baud Rate</p> 
<ol style="list-style-type: none"> 1. Press key  until to CR character. 2. Press key , a cursor appears. 3. Press key , select YES or no. 4. Press key , confirm the selection, the cursor disappears. <p>(confirm YES means clear energy)</p>	<p>Clear Energy</p> 

<ol style="list-style-type: none"> 1. Press key  until to "E-" character. 2. Press key , a cursor appears. 3. Press key , select 0, 1 or 2. 4. Press key , confirm the selection, the cursor disappears. <p>"0" means to display input active energy, "1" means to display output active energy, "2" means to display total active energy.</p>	<p>Set the displaying of energy</p> 
<ol style="list-style-type: none"> 1. Press key , check the version of Meter. 	<p>Version of Meter</p> 

Note: Due to be limited by size of LED window, other parameters such as reactive power, power factor etc. , shall be set via communication.

6. Input/ Output Characteristics

6.1 Status Input

PMAC615 provides two status input channels, which are used to detect state information such as breaker position signal and isolator position signal.

There is no power provided from the device. When local application requires the status input to detect signal, it should be connect to an external 220VAC/ DC power supply. When external node is closed, the corresponding status input channel will be clear. Refer to below drawing:

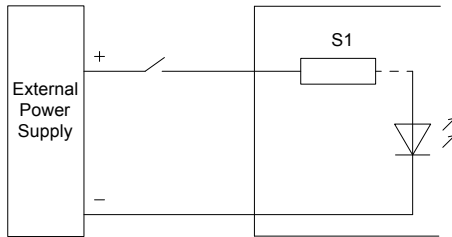

Note: Because there is no internal power supply, the external node must be connected to outside power, otherwise, the status input channel don't work. External power supply: 220VAC/DC±25%.

6.2 Relay Output

PMAC615 provides two relay operation modes. They are remote control and local control. Users shall distinguish the relay is in local control mode or in remote control mode. In different mode, the operation to relay is different.

The default mode of the meter is in remote control mode. Users can change the mode through communication.

- ◆ Remote control (external)—The relay is controlled by a PC or PLC by using commands through communication.
- ◆ Local control (internal)—The relay is controlled by one of the electrical parameters inside the meter, which serves as the response to the control alarm conditions of a set point.

Once the relay has been in remote control mode, even though the local control conditions have been set, the relay will not operate. The relay mode must be set at local control mode.

The two relay operation modes are as follow:

- ◆ Normal:
 - Remote control: By receiving a command from a PC or PLC, the relay close. The relay's status will be kept until the PC or PLC gives a release command or the meter is de-energized.
 - Local control: When an alarm signal activating the relay is generated, the relay operates. The relay will not be released until all the alarm conditions activating the relay disappear or the meter is de-energized. If the power supply for the meter is resumed and the alarm conditions still exist, the relay will operate again.
- ◆ Time delay reset
 - Remote control: By receiving a command from a PC or PLC, the relay operates. The relay's operating status will be kept until a special timer overflows or the meter is de-energized. If, before the timer overflows,

there is a new command that makes the relay operates, the timer will restart.

- Local control: When an alarm signal activating the relay is generated, the relay operates. The relay's operating status will be kept within the period of time for timing. When the timer overflows, the relay will be released and kept released.

7. Setpoint Alarm

PMAC615 provides one relay alarm output which is programmable.

When the relay output is set to in local control mode, it indicates corresponding set point alarm. There are 5 parameters may be set under setpoint alarm feature. Refer to below sheet:

Operation object	0 - Prohibit
	1 – Voltage
	2 – Current
Operation upper limit value	0% - 120% of rating
Operation lower limit value	0% - 120% of rating
Operation time delay	0 - 1200s, 0 means the relay operates immediately.
Return time	0 - 1200s, 0 means non-return.

Suppose that, Users want to know if there is undervoltage situation. It is required that if in undervoltage situation, it alarms immediately, until normal voltage is resumed. The programming procedure as follow:

Operation object: Voltage

Operation upper limit: 120

Operation lower limit: 80 (Assumed that, when voltage is lower than 80% of rating, it is undervoltage.)

Operation time: 0s

Return time: 0s

Other values can be set according to above mentioned procedure, and the relating programming is not described here one by one.

8. Communication Protocol

8.1 Overview

PMAC615 supports the MODBUS-RTU communication protocol, 8 data bits, 1 stop bit, without check bit. Each frame data package contains the address field, functional code field, data field, and check field. The maximum length of each data package is 45 bytes.

The length of address field is 1 byte, and the content is slave station address. The range of an effective slave station address is 1 to 247. If the slave station receives a package in which the address field information conforms to its own address, it should execute the command contained in the package. In the package to which the slave station responds, the field is its own address.

The length of functional code field is 1 byte, used to inform slave station to execute what operations. The functional codes supported by PMAC615 are listed as following table:

Functional Code	Meaning	Function
0x03	Read register	Obtain one or more than one current register value inside the current PMAC615.
0x10	Set register	Write the designated value into one or more than one registers inside PMAC615.
0x05	Relay control	Control a relay inside the current PMAC615.

The length of the data field is not fixed, and it will be defined according to the specific function. The data in the data field adopts the BIG INDIAN mode, with the high bytes in front and the low bytes at back.

The check field adopts 16-bit CRC check codes. The transmitting device should make CRC calculation for each of the data inside the package, and the final results will be stored in the check field. The receiving device should also make CRC calculation for each of the data (except the check field) inside the package and compare the results with the check field. Only the same package will be accepted.

8.2 Abnormal Response

If the master sends an illegal package or asks for an invalid data register, an abnormal data response will be generated. This abnormal data response is composed of the slave address, functional code, fault code and check field. When the highest bit of the functional code field is 1, it means that the data frame is an abnormal response at this time. The table below describes the meanings of abnormal functional codes:

Fault Code	Description
01H	Receive illegal operation functional code
02H	Receive illegal register operation or over-long data

8.3 Relay Control

The functional code is 05H.

In this mode, only individual relay can be controlled. The status of the relay can be obtained by reading the relay status register. Send hexadecimal FF 00 to close the relay. Send hexadecimal 00 00 to release the relay. All other value is invalid.

Control relay format (master→PMAC615)		Response format (PMAC615→master)	
Slave address	1 byte	Slave address	1 byte
Functional code 05H	1 byte	Functional code 05H	1 byte
Channel address	2 bytes	Channel address	2 bytes
Control command	2 bytes	Control command	2 bytes
CRC check code	2 bytes	CRC check code	2 bytes

8.4 Register Reading

The functional code is 03H. The master can read one or more than one register value, and the register return value which not defined are 0.

Read register format (master→PMAC615)		Response format (PMAC615→ master)	
Slave address	1 byte	Slave address	1 byte
Functional code 03H	1 byte	Functional code 03H	1 byte
Starting address	2 bytes	Byte number (2× number of register)	1 byte
Number of register	2 bytes	Data of the first register	2 bytes
CRC check code	2 bytes	Data of the second register	2 bytes
		
		CRC check code	2 bytes

Note: One time can read 20 registers value at most.

8.5 Set the Register

The functional code is 10H. The master can set one or more than one register value. Other operation for non-defined register is invalid.

Write register format (master→PMAC615)		Response format (PMAC615→ master)	
Slave address	1 byte	Slave address	1 byte
Functional code 10H	1 byte	Functional code 10H	1 byte
Starting address	2 bytes	Starting address	2 bytes

Number of register	2 bytes	Number of register	2 bytes
Byte number (2× number of register)	1 byte	CRC check code	2 bytes
Data of the first register			
Data of the second register			
.....			
CRC check code	2 bytes		

8.6 Type of Register Instruction

UINT16	Unsigned 16-digit integer
INT16	Signed 16-digit integer
LUINT32	Unsigned 32-digit integer
LINT32	Signed 32-digit integer
WORD16	<p>Bit denotation word, applicable to no-off and relay status</p> <p>D0 means the first status channel or relay channel</p> <p>D1 means the second status channel or relay channel</p> <p>The rest bits may be deduced by analogy.</p> <p>Bit 0 means “cut off”, and bit 1 means “close on”</p>

8.7 Calculation Factor

Because there is a limit of value, many of data registers of PMAC615 use the calculation factor. It means that, if Users want to obtain the actual value, the value should be multiplied by the corresponding calculation factor.

For example, the calculation factor of power factor register is 0.001. If the reading value is

892 at this moment, the actual value if current power factor is $892 \times 0.001 = 0.892$.

8.8 Communication Value and Actual Value

To ensure that the meter keeps adequate accuracy bits when transmitting data, some of real-time data registers of PMAC615 adopt some special methods, shown as following sheet:

No.	Content	Communication Value	Actual Value
1	Current Voltage	Secondary side	Communication value \times calculation factor \times CT ratio

Using secondary side to transmit value can keep the calculation accuracy to the utmost extent. Users must, during processing, pay attention to the corresponding CT ratio or PT ratio.

8.9 List of Real-time Measurement Data Register

Register Address	Definition	Description	
40001	Current	Secondary current, calculation factor is 0.001. Unit: Ampere	
40002	Voltage	Secondary voltage, calculation factor is 0.01. Unit: Volt	
40003	Active power	Secondary active power, calculation factor is 0.1. Unit: Watt	The highest bit is the sign bit. Negative value is represented by complement.
40004	Reactive power	Secondary reactive power, calculation factor is 0.1. Unit: Var	
40005	Power factor	Calculation factor is 0.001.	
40006	Frequency	Calculation factor is 0.01. Unit: Hz	

40007	Status channel	D0 means S1 channel, D1 means S2 channel. 0 means cut off, 1 means closed.
40008	Relay channel	0 means cut off, 1 means closed.
40009	Total active energy low word	Calculation factor is 0.1. Total value of import and export energy. Unit: kWh
40010	Total active energy high word	
40011	Null	Null
40012	Null	
40013	Import active energy low word	Calculation factor is 0.1. Total value of import and export energy. Unit: kWh
40014	Import active energy high word	
40015	Export active energy low word	
40016	Export active energy high word	
40017	Null	Null
40018	Null	
40019	Null	
40020	Null	

8.10 List of Configuration Registers

Register Address	Definition	Description
40201	CT ratio	The ratio of external CT primary to secondary.

		Range: 1~9999
40202	Communication address	Range: 1 ~ 247
40203	Baud rate	0 means 4800bps, 1 means 9600bps
40204	Clear energy	WO, write 0x00FF to clear energy.
40205	Select the display of energy	0: Display import active energy 1: Display export active energy 2: Display total active energy
40206	Null	Null
40207	Null	Null
40208	Relay operation mode	0 means local, 1 means remote.
40209	Relay operation object	0 means prohibit, 1 means voltage, 1 means current.
40210	Relay operation upper limit	The percentage of operation upper limit to rating. Range: 0~120.
40211	Relay operation lower limit	The percentage of operation lower limit to rating. Range: 0~120.
40212	Relay operation time	Range: 0~1200. Unit: second. 0 means operate immediately.
40213	Relay return time	Range: 0~1200. 0 means non-return.

8.11 05H Command Control Relay

Register Address	Definition	Description
------------------	------------	-------------

05H command	Relay control	Write FF00 to close on the relay, write 0 to release the relay.
----------------	---------------	---

9. Maintenance and Trouble Shooting

Possible Problem	Possible Reason	Possible Solution
The meter has no indication after a control power supply is imposed	The power supply fails to be imposed on the meter	<p>Check if the correct working voltage has been imposed on the L/+ and N/- terminals of the meter.</p> <p>Check if the fuse for the control power supply has been burnt down.</p>
The measured value is not correct or does not conform to the expectation.	The voltage measurement is not correct.	<p>Check if the neutral point has been connected reliably.</p> <p>Check if the measured voltage matches the rated parameter of the meter.</p> <p>Check if the transformation ratio of the PT has been set correctly.</p>
	The current measurement is not correct.	<p>Check if the measured current matches the rated parameter of the meter.</p> <p>Check if the transformation ratio of the CT has been set correctly.</p>
	The power measurement is not	Check if the measurement mode has been set correctly.

	correct.	<p>Check if the phase sequence corresponding to the voltage and the current is correct.</p> <p>Check if the current terminals of the same name are wrong.</p>
There is no change in the on-off status.	The on-off operating voltage is not correct.	<p>Check if the types of external nodes match the rated parameters of the meter.</p> <p>Check if the external connection is correct.</p>
The relay does not operate.	The relay does not receive the control command.	Check if the communication link is correct.
	The working mode of the relay is not correct.	Check if the current relay is under the correct mode.
	The operating time has not been set correctly.	Check the setting of the operating time of the relay. For the specific information, refer to the content regarding relays of the operation manual.
There is no communication between the upper end device and the meter.	The communication address of the meter is not correct.	Check if the address of the meter is consistent with its definition or if there are more than two identical addresses in the same network.
	The communication speed of the meter is not	Check if the communication speed of the meter is consistent with its definition.

	correct.	
	The communication link has not been connected to the terminal resistor.	Check if the 120-Ohm resistor has been connected.
	The communication link suffers interference.	Check if the communication-shielding layer has been earthed effectively.
	The communication line is interrupted.	Check if the communication cable has been disconnected.

10. Technical Datasheet

Structural Dimensions	Panel: 110.00×65.00mm Installation: 90.50×45.00mm Depth: 55.00mm
Display	High-light LED
Terminals Connection	Standard 5.08mm pluggable terminals
Power Supply	85-265VAC/45-65Hz. 100-300VDC

Measurement Accuracy	
Voltage	0.2%
Current	0.2%
Active Power	0.5%
Power Factor	0.5%
Active Energy	1.0%

Environment	
Operating Temperature	-20°C - +60°C
Storage Temperature	-30°C - +70°C
Relative Humidity	5% - 90%RH, non-condensing

EMC	
Electrostatic Discharge Immunity Test	IEC 61000-4-2,Level 4
Radiated immunity test	IEC 61000-4-3,Level 3
Electrical fast transient/burst immunity test	IEC 61000-4-4,Level 4
Surge immunity test (1, 2/50µs~8/20µs)	IEC 61000-4-5,Level 3
Conducted emissions	EN 55022,Class B
Radiated emissions	EN 55022,Class B

Notice:

- Zhuhai Pilot Electronics reserves the right to modify this manual without prior notice in view of continued improvement.
- Technical Consulting: +86 15916202620
- After-sale Services: +86 15916202800
- Email: pilot166@pmac.com.cn

Pilot Zhuhai Pilot Electronics Co., Ltd.

Add: No. 15, Keji 6 Road, Chuangxin Haian, Tangjia High-tech Zone, Zhuhai, Guangdong, China-519085

Tel: +86 -756-3629687/ 3629688

Fax: +86-756-3629600/ 3629670

<http://www.pmac.com.cn>